

RDG100...

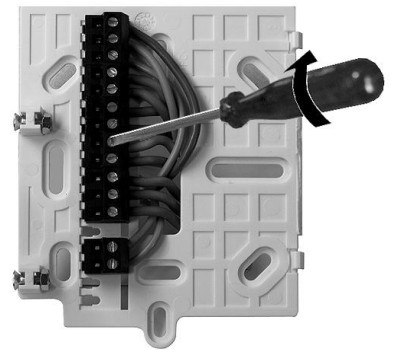

Max. 1 x 2.5 mm² (1 x 14 gauge)
Max. 2 x 1.5 mm² (2 x 16 gauge)

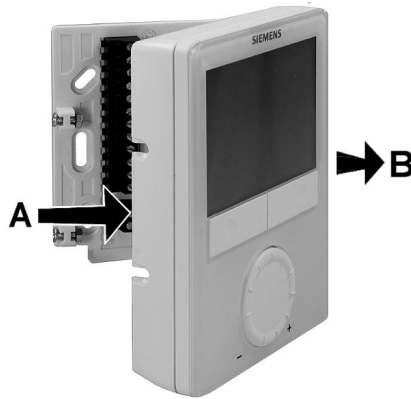
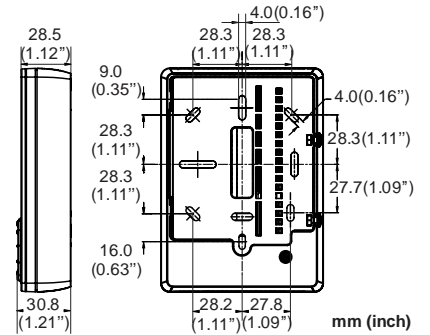
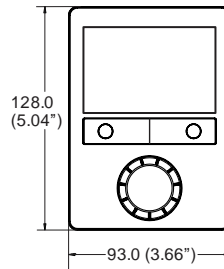
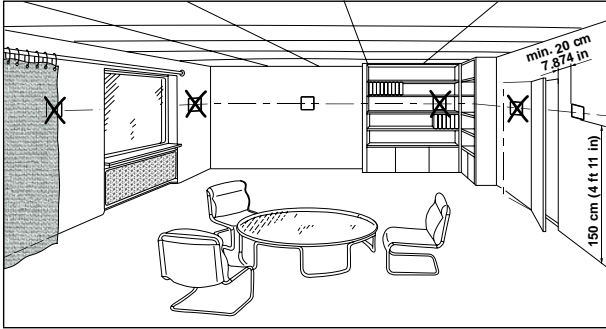

Max. 80 m (262 feet)

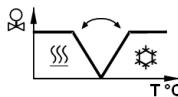
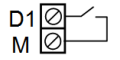
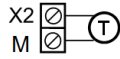
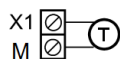

3181Z111

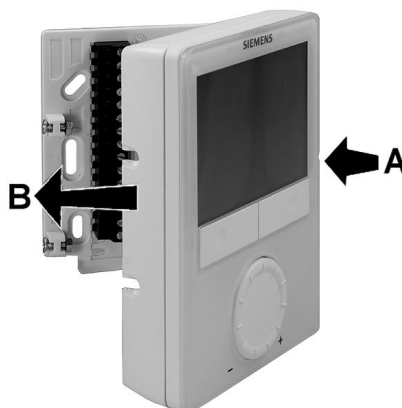
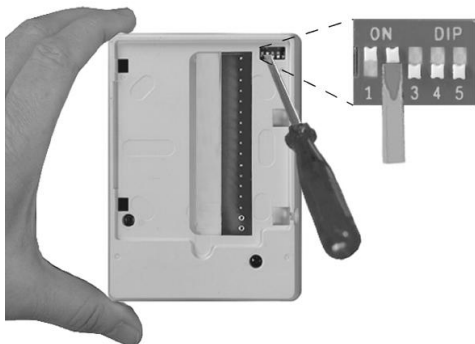
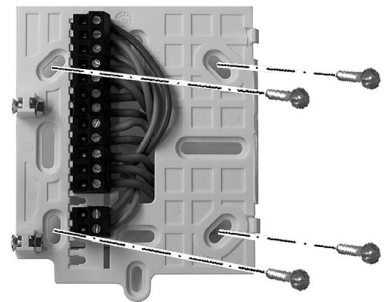

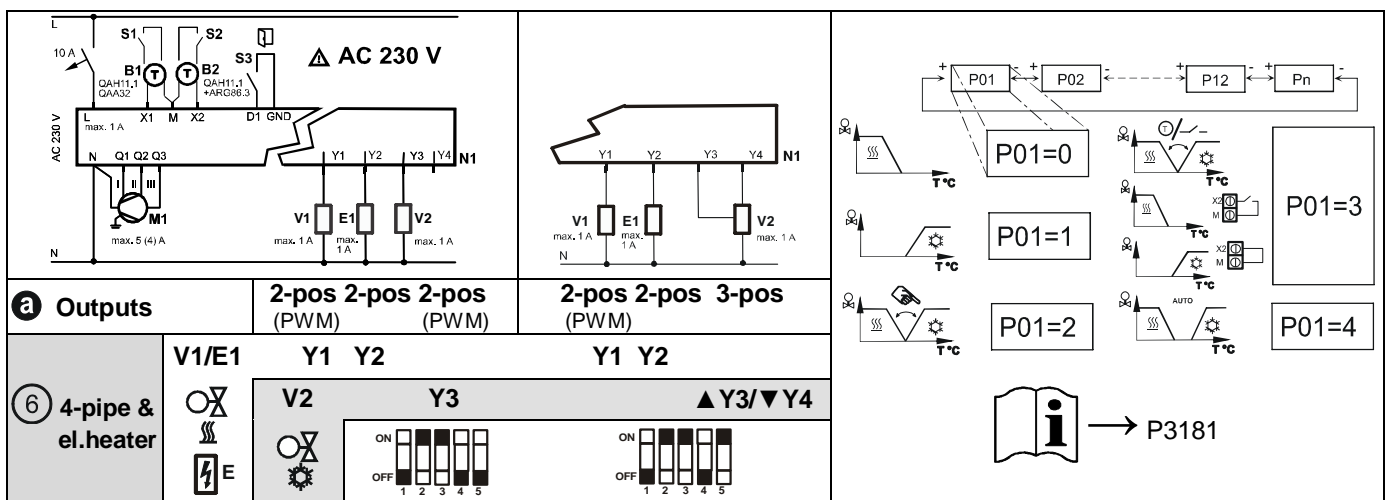
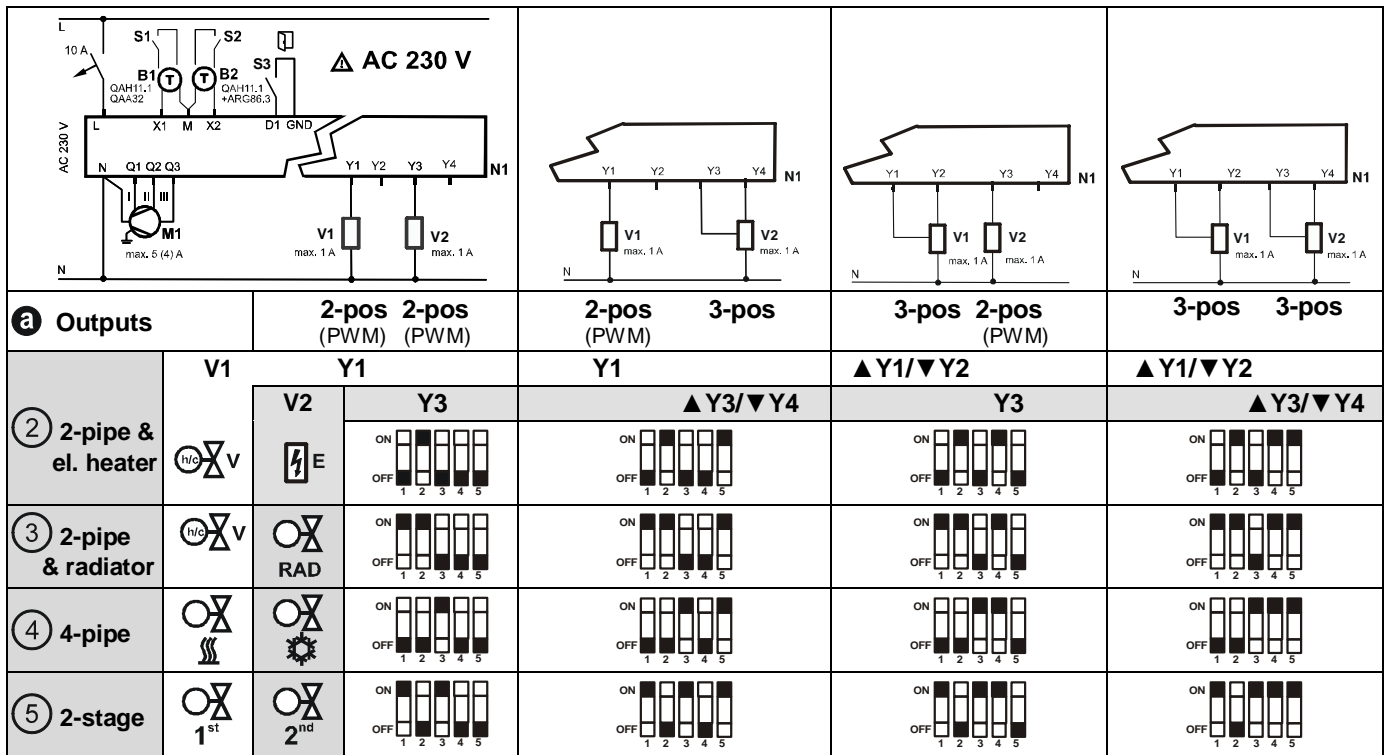
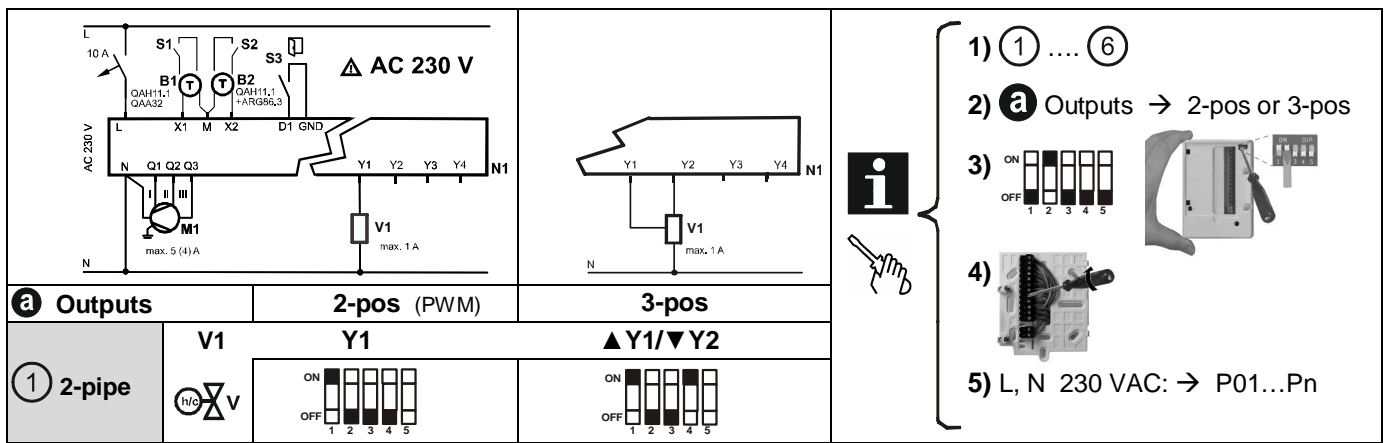

	en	de	fr	it	es	cs	tr
①	2-pipe fan coil	2-Rohr Ventilator-konvektor	Ventiloconvecteur 2 tubes	Fan coil 2 tubi	Fancoil a dos tubos	2-trubkový fan-coil	2 borulu fan coil
②	2-pipe & el. heater	2-Rohranwendung & Elektroheizer	Application 2 tubes & batterie électrique	Fan coil 2 tubi con batteria elettrica di riscaldamento	2 tubos & batería eléctrica	2-trubkový fan-coil & el. ohřev	2 borulu & elk. Isitici
③	2-pipe & radiator	2-Rohranwendung & Radiatorventil	Application 2 tubes & vanne thermostatique	Fan coil 2 tubi e radiatore	2 tubos & rad	2-trubkový fan-coil & radiátor	2 borulu & radyatör
④	4-pipe fan coil	4-Rohr Ventilator-konvektor	Ventiloconvecteur 4 tubes	Fan coil 4 tubi	Fancoil a 4 tubos	4-trubkový fan-coil	4 borulu fan coil
⑤	2-stage	2-Stufen-Anwendung	Application à 2 étages	2 stadi	2 etapas	2-stupňový	2 kademe
⑥	4-pipe & el. heater	4-Rohranwendung & Elektroheizer	Application 4 tubes & batterie électrique	Fan coil 4 tubi con batteria elettrica di riscaldamento	4 tubos & batería eléctrica	4-trubkový fan-coil & el. ohřev	4 borulu fan coil & elk. Isitici