

RDF300...
RDF300.../VB
RDF340...
RDF400...

Mounting Location of Thermostat / 温控器安装位置 / Termostatın Montaj Yeri

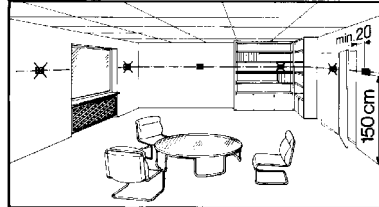

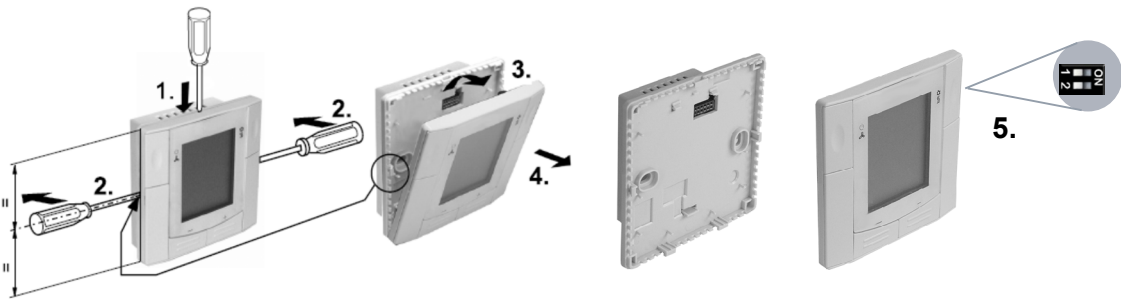





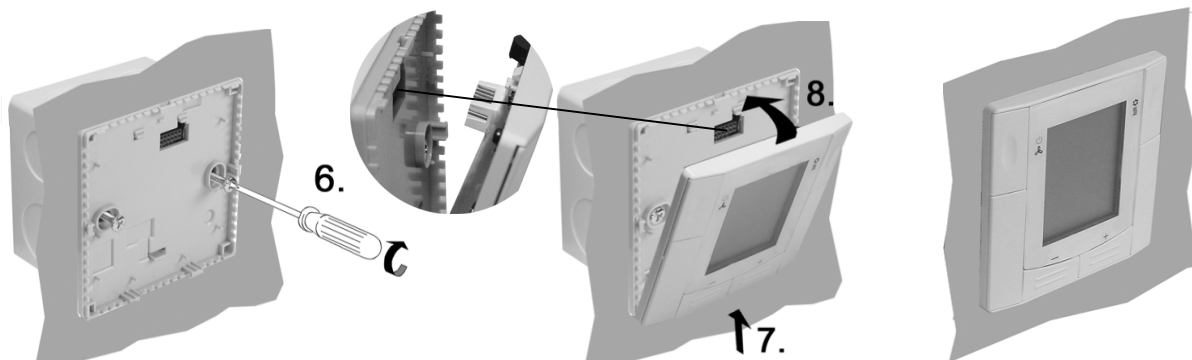
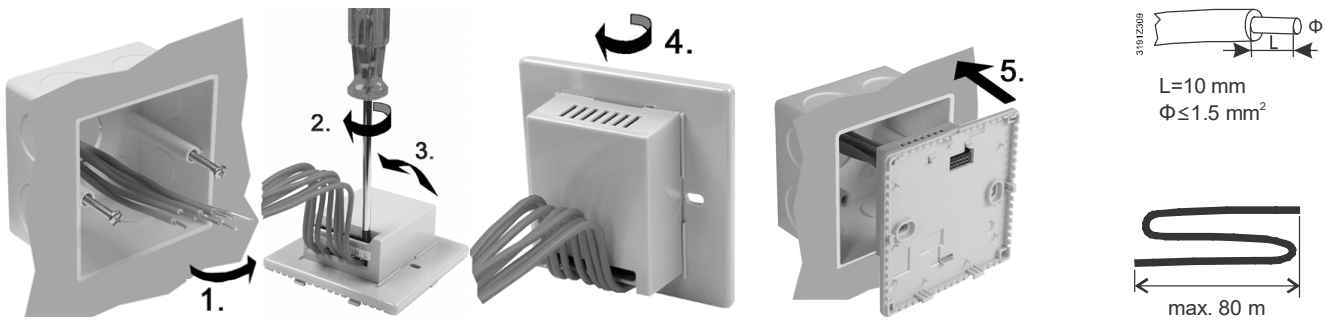

Preparation and Deliverables / 安装前准备 / Hazırlık ve Ürünle Gelenler

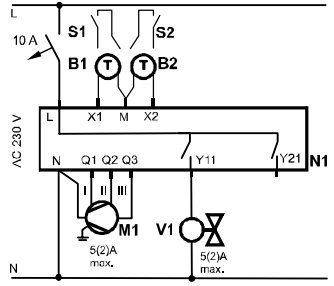
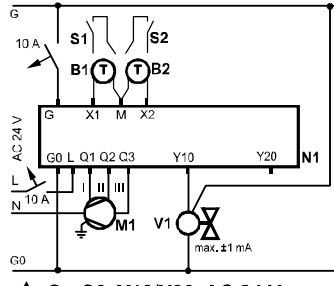
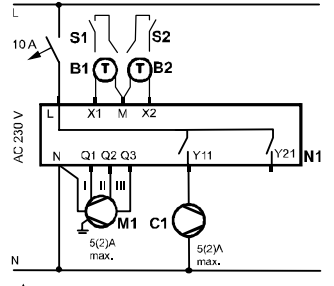

Flush-Mounting / 嵌入式安装 / Gömme Montaj

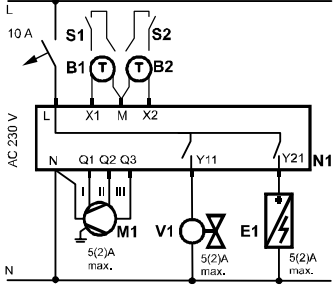
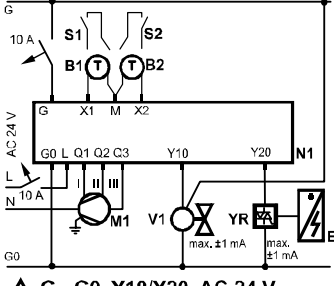
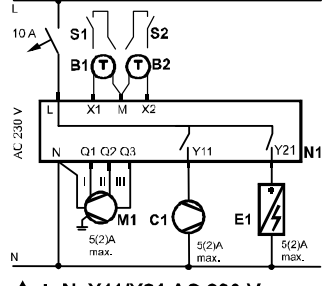

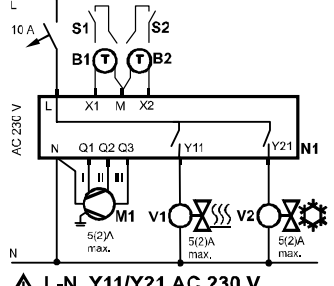
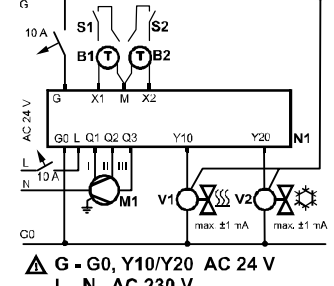
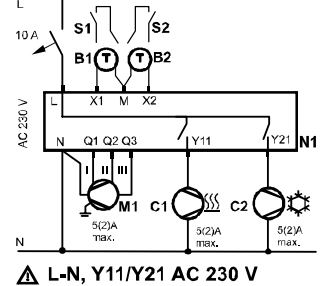
Wiring Diagrams / 接线图 / KabloLama Diyagramları

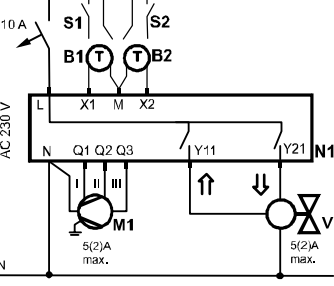
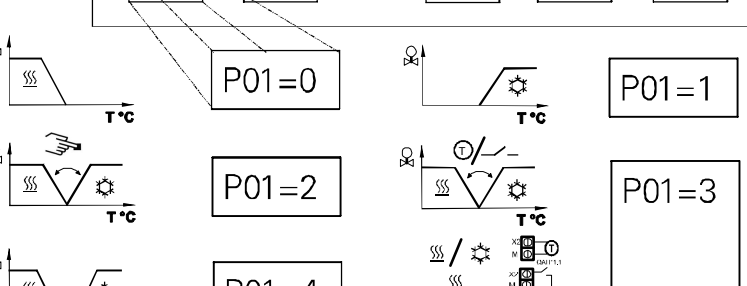
Application 应用 Uygulama			
	RDF300... / RDF300.../VB / RDF400...	RDF340	RDF300... / RDF300.../VB / RDF400...
 en 2-pipe zh 两管制 tr 2 boru	 <p>△ L-N, Y11/Y21 AC 230 V</p>	 <p>△ G - G0, Y10/Y20 AC 24 V L - N AC 230 V</p>	 <p>△ L-N, Y11/Y12 AC 230 V</p>
 en 2-pipe & el. heater zh 两管制, 带电加热 tr 2 boru ve elektrikli ısıtıcı	 <p>△ L-N, Y11/Y21 AC 230 V</p>	 <p>△ G - G0, Y10/Y20 AC 24 V L - N AC 230 V</p>	 <p>△ L-N, Y11/Y21 AC 230 V</p>
 en 4-pipe zh 四管制 tr 4 boru	 <p>△ L-N, Y11/Y21 AC 230 V</p>	 <p>△ G - G0, Y10/Y20 AC 24 V L - N AC 230 V</p>	 <p>△ L-N, Y11/Y21 AC 230 V</p>
 en 2-pipe, 3 position output zh 两管制, 三位控制输出 tr 2 borulu, 3 konumlu çıkış	 <p>△ L-N, Y11/Y21 AC 230 V</p>		

Legend: / 图例 / Açıklama

en	zh	tr
N1	RDF3xx / RDF4xx	RDF3xx / RDF4xx
M1	3-speed fan	三速风机
V1, V2	Valve	阀门
C1, C2	Compressor	压缩机
E1	Electro heater	电加热
S1, S2	Operating mode switch-over contact (e.g. key card)	工作模式转换开关 (例如: 门卡)
YR	Current valve	电流阀
B1, B2	Heat/cool changeover sensor	制冷/供热转换传感器
		RDF3xx / RDF4xx
		3 hızlı fan
		Valf
		Kompresör
		Elektro ısıtıcı
		Çalışma modu geçiş kontağı (ör. anahtar kartı)
		Akım valfi
		Isıtma/soğutma geçiş sensörü

Dimensions / 尺寸 / Boyutlar

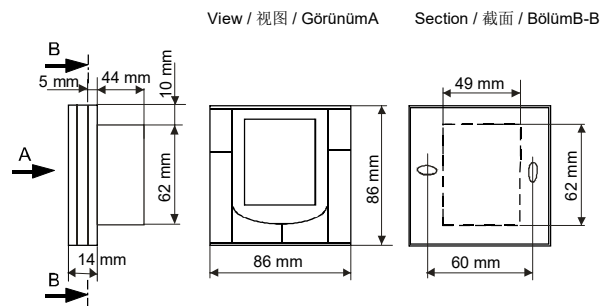

Issued by
Siemens Switzerland Ltd
Smart Infrastructure
Global Headquarters
Theilerstrasse 1a
CH-6300 Zug
Tel. +41 58 724 2424
www.siemens.com/buildingtechnologies

© Siemens Switzerland Ltd, 2008
Technical specifications and availability subject to change without notice.