

MOUNTING

The device can be installed in dry surroundings (IP20) by screws on the wall surface or on the standard flush mounting box. The recommended installation height is 150...180 cm.

The device position should be selected carefully. All the error factors that can affect to the measurements should be eliminated as well as possible. The following list defines the typical measurement error factors.

- direct sun light
- occupant proximity
- air flow coming from windows or doors
- air flow coming from ventilation nozzles
- air flow coming from the flush mounting box
- differential temperature caused by external wall

Wiring



Device wiring and commissioning can only be carried out by qualified professionals. Always make the wirings while the power is switched off.

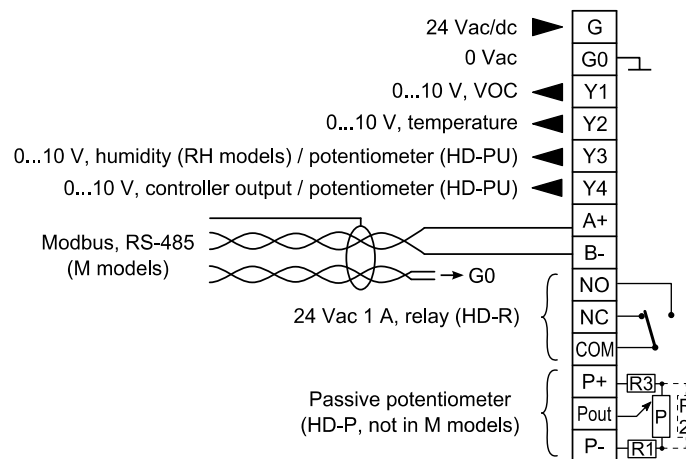

SELECTING THE MEASUREMENT INFORMATION TO BE VIEWED ON THE DISPLAY

The measurement values scroll on the N model display. The wanted value can be locked to view continuously by pressing the S1 button. You resume to the scrolling view by pressing the S1 button again.

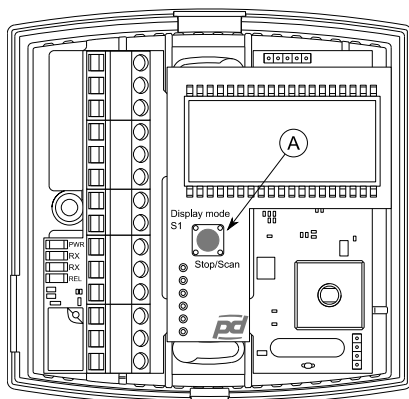

A. S1 button

NOTE: In M models, the shown measurement information can be selected also via Modbus.

ML-SER TOOL

With the ML-SER tool you can change the device settings, controller and Modbus settings for example.

Connecting ML-SER tool to the device

1. Remove the display / HD-AL3 option.
2. Connect the ML-SER cable to the connector.

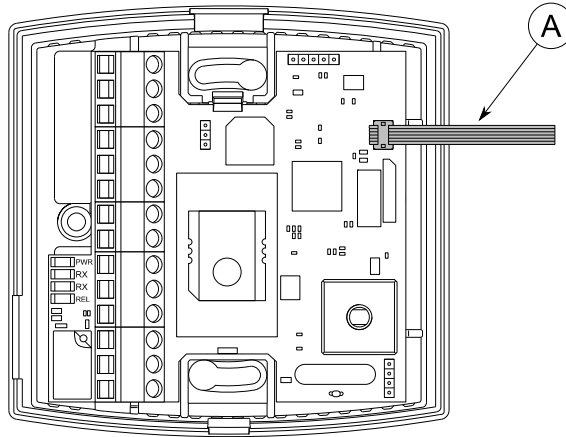

A. ML-SER cable

VOC measurement value shows on the ML-SER tool display.

ML-SER menu

ML-SER menu opens by pressing the M button. The values can be changed with the "+" and "-" buttons. The menu is device-specific and the content depends on the device and installed options.

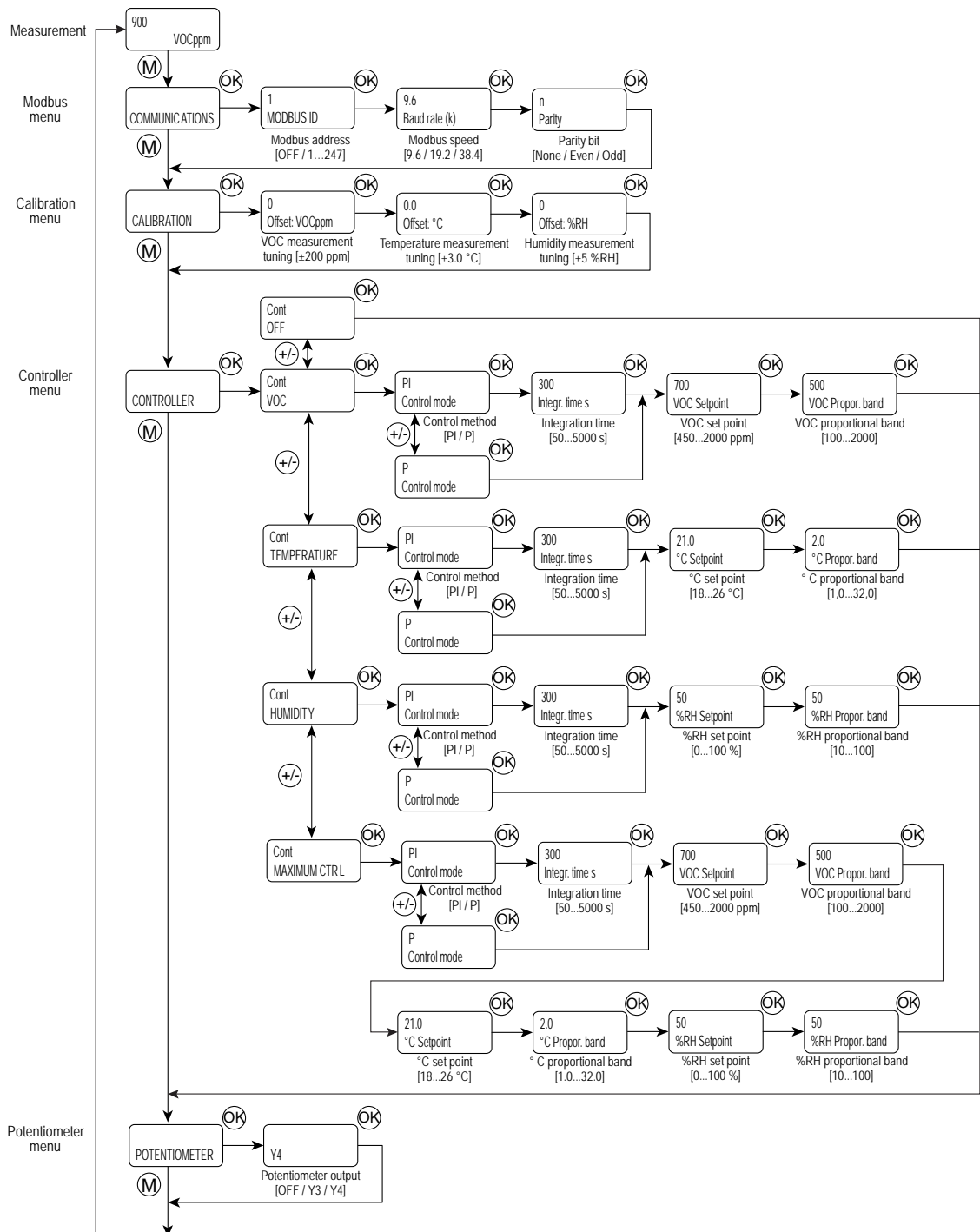

The diagram continues on the next page.

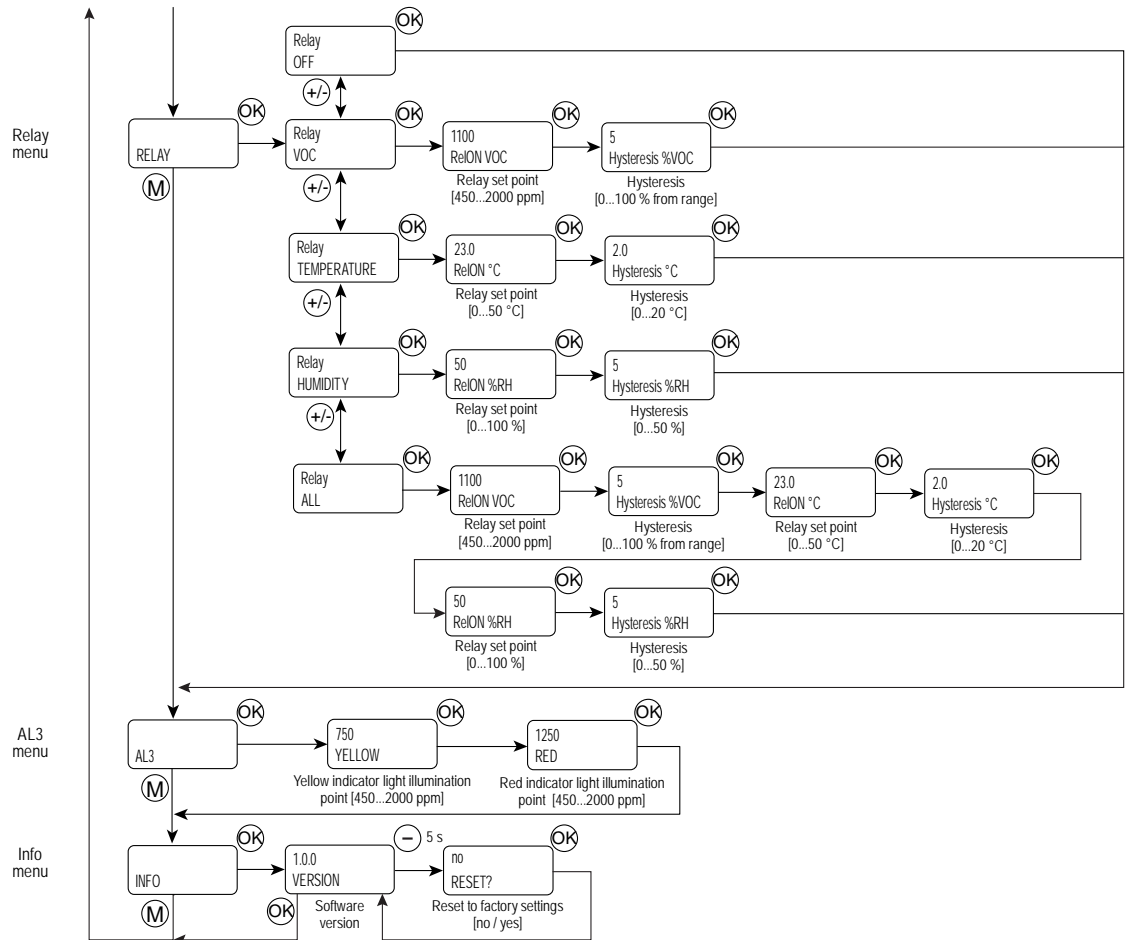

Modbus menu

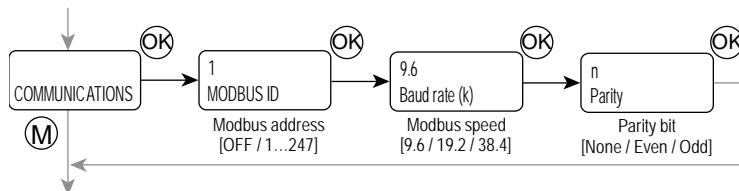

Modbus menu is available in M models. The bus settings can be changed through the menu.

Calibration menu

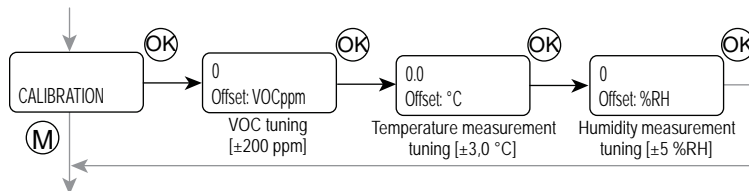

All the measurements can be tuned through the calibration menu. The humidity tuning is available only in RH models.

- The VOC value can be adjusted by 10 ppm steps.
- The temperature value can be adjusted by 0.1 °C steps.
- The humidity value can be adjusted by 1 % steps.

ML-SER tool display shows how much the current value is tuned.

Controller menu

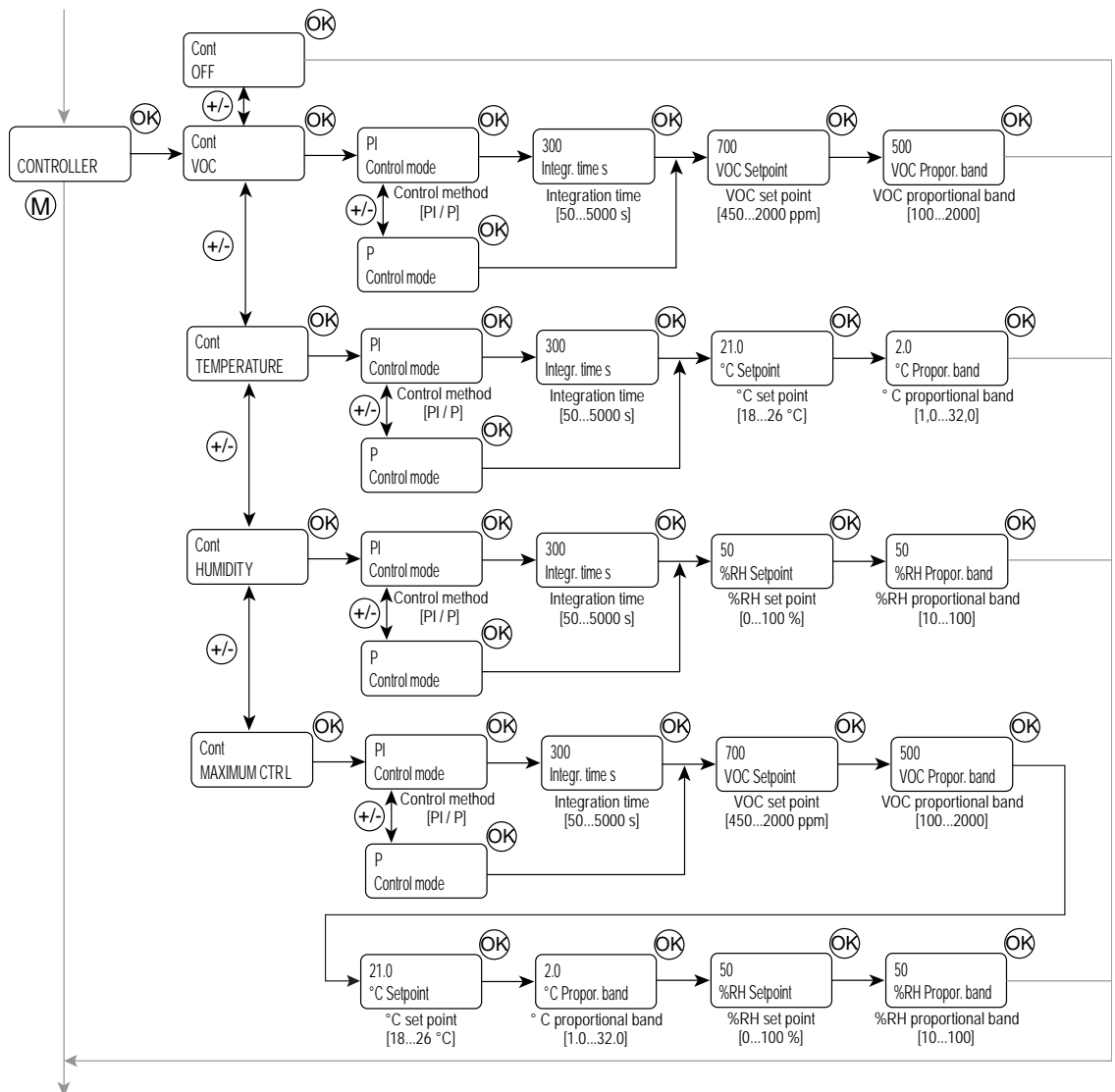

The control output can be controlled either according to a one measurement value or according to the maximum selection of all values. Humidity related settings are only available in RH models.

- The VOC values can be adjusted by 10 ppm steps.
- The temperature values can be adjusted by 0.1 °C steps.
- The humidity values can be adjusted by 5 % steps.

In the maximum selection control, the control output signal is formed according to the measurement that causes the largest control signal value. The following situation is in the example figure:

- VOC level is 800 ppm
- Temperature is 21.5 °C
- Humidity is 55 %

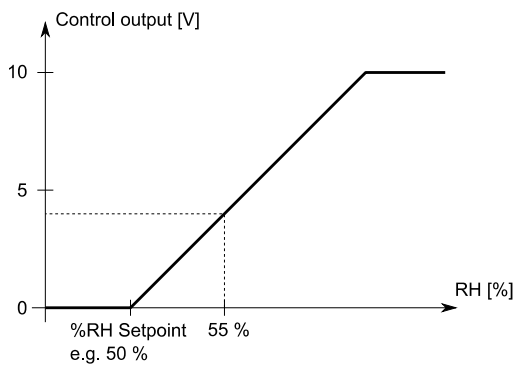
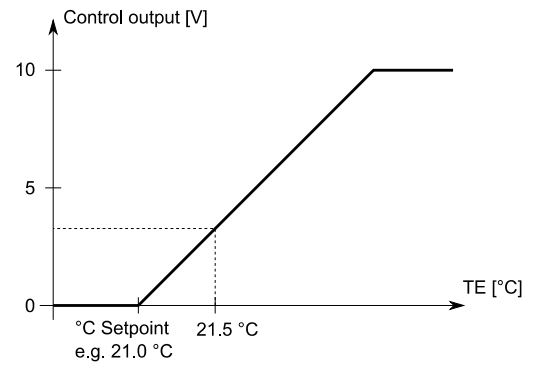
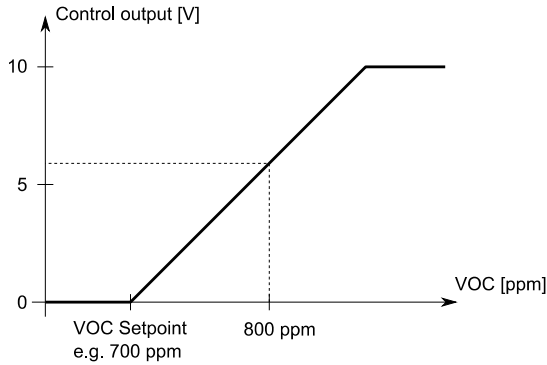

VOC = 6 V
Temperature = 3 V
Humidity = 4 V } → Control output = 6 V

Potentiometer menu

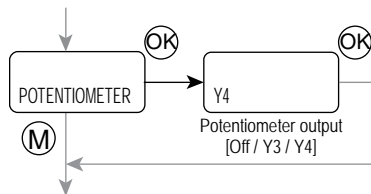

Potentiometer menu is available if HD-PU option is installed. You can select the potentiometer output connector and disable the potentiometer through the menu. The potentiometer is connected to the Y4 output as factory setting.

Relay menu

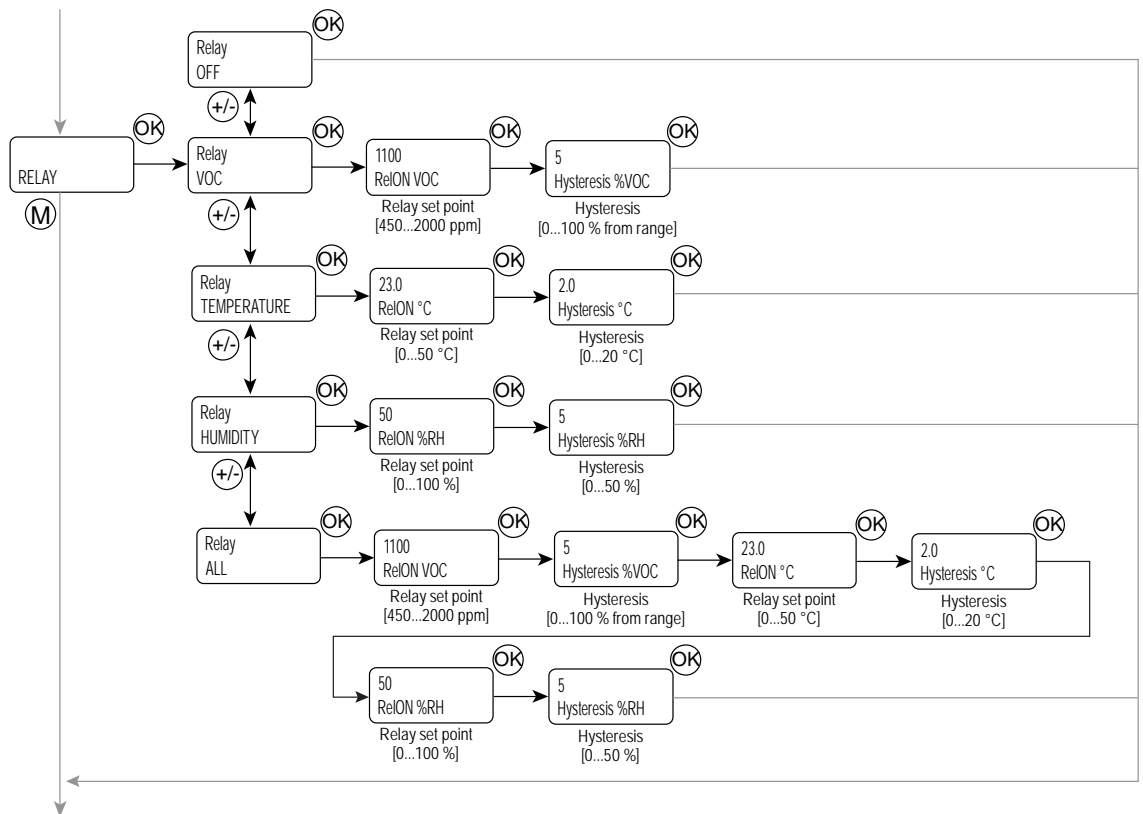

Relay menu is available if HD-R option is installed. The relay switching point and hysteresis can be changed through the menu.

The relay output can be controlled either according to a one measurement value or according to the all values. Humidity related settings are only available in RH models.

- The VOC values can be adjusted by 10 ppm steps.
- The temperature values can be adjusted by 0.1 °C steps.
- The humidity values can be adjusted by 1 % steps.

When the output is controlled according to the all values, the relay activates when one measured value exceeds the set point.

AL3 menu

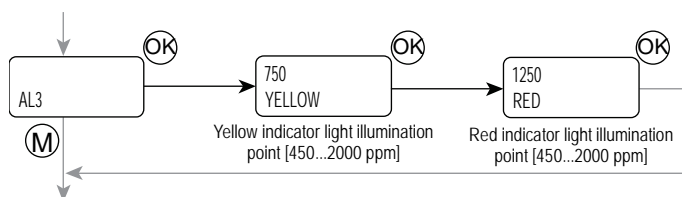

AL3 menu is available if HD-AL3 option is installed. The indicator light limits can be changed through the menu. The hysteresis is 50 ppm.

Info menu

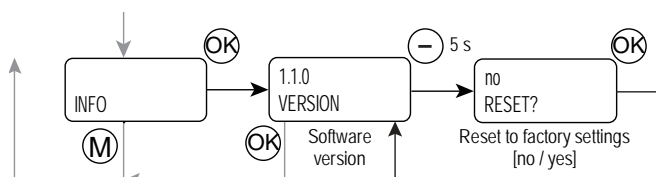

You can check the device software version and reset the device to factory settings through the Info menu.

MODBUS

Bus properties

Protocol	RS-485 Modbus RTU
Bus speed	9600/19200/38400 bps
Data bits	8
Parity	none/odd/even
Stop bits	1
Network size	up to 128 devices per segment

The parameter memory durability allows at least 1 million writing cycles.

Bus termination

The Modbus can be terminated by placing the MBUS TERM. jumper.

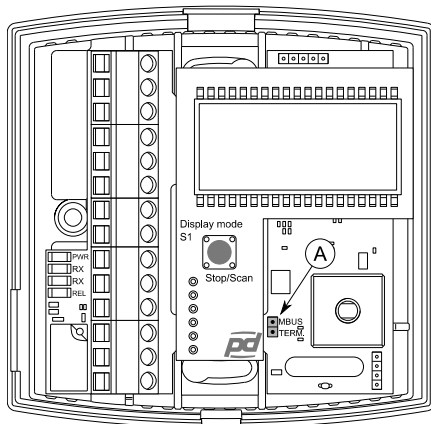

A. MBUS TERM. jumper

Modbus function codes

The device supports the following Modbus function codes.

0x01	Read Coils
0x02	Read Discrete Inputs
0x03	Read Holding Registers
0x04	Read Input Registers
0x05	Write Single Coil
0x06	Write Single Register
0x0F	Write Multiple Coils
0x10	Write Multiple Registers
0x17	Read/Write Multiple Registers

Modbus registers

NOTE: If you try to write a parameter value that is beyond the parameter value range, the value will be replaced by the nearest acceptable value. For example, if you write 270 to the register 40011, the value will be replaced by 260.

Coils

Register	Parameter description	Data type	Values	Range	Default
1	Y1 output overdrive activation	Bit	0 - 1	0: Off, 1: On	0
2	Y2 output overdrive activation	Bit	0 - 1	0: Off, 1: On	0
3	Y3 output overdrive activation	Bit	0 - 1	0: Off, 1: On	0
4	Y4 output overdrive activation	Bit	0 - 1	0: Off, 1: On	0
5	Relay overdrive activation	Bit	0 - 1	0: Off, 1: On	0
6	Relay overdrive	Bit	0 - 1	0: Off, 1: On	0

Discrete inputs

Register	Parameter description	Data type	Values	Range
10001	Relay status	Bit	0 - 1	0: Off, 1: On

Input registers

Register	Parameter description	Data type	Values	Range
30001	VOC measurement (CO ₂ equivalent)	Signed 16	0...10000	0...10000 ppm
30002	Temperature measurement	Signed 16	0...500	0.0...50.0 °C
30003	Humidity measurement	Signed 16	0...1000	0.0...100.0 %
30004	Y1 output voltage	Unsigned 16	0...1000	0.00...10.00 V
30005	Y2 output voltage	Unsigned 16	0...1000	0.00...10.00 V
30006	Y3 output voltage	Unsigned 16	0...1000	0.00...10.00 V
30007	Y4 output voltage	Unsigned 16	0...1000	0.00...10.00 V
30008	Active potentiometer value	Unsigned 16	0...1000	0.0...100.0 %

Holding registers

Register	Parameter description	Data type	Values	Range	Default
40001	Y1 output overdrive	Signed 16	0...1000	0...10.00 V	0
40002	Y2 output overdrive	Signed 16	0...1000	0...10.00 V	0
40003	Y3 output overdrive	Signed 16	0...1000	0...10.00 V	0
40004	Y4 output overdrive	Signed 16	0...1000	0...10.00 V	0
40005	VOC measurement tuning (offset)	Signed 16	-200...200	-200...200 ppm	0
40006	Temperature measurement tuning (offset)	Signed 16	-30...30	-3.0...3.0 °C	0
40007	Humidity measurement tuning (offset)	Signed 16	-5...5	-5...5 %	0
40008	Control method	Signed 16	0 - 1	0: P 1: PI	1
40009	Controller output	Signed 16	0 - 1 - 2 - 3 - 4	0: not in use 1: VOC 2: temperature 3: humidity 4: maximum selection	1
40010	Set point, VOC	Signed 16	450...2000	450...2000 ppm	700
40011	Set point, temperature	Signed 16	180...260	18.0...26.0 °C	210
40012	Set point, humidity	Signed 16	0...100	0...100 %	50
40013	Proportional band, VOC	Signed 16	100...2000	100...2000 ppm	500

Register	Parameter description	Data type	Values	Range	Default
40014	Proportional band, temperature	Signed 16	10...320	1.0...32.0 °C	20
40015	Proportional band, humidity	Signed 16	10...100	10...100 %	50
40016	Integration time	Signed 16	50...5000	50...5000 s	300
40017	Active potentiometer output	Signed 16	0 - 1 - 2	0: OFF 1: Y3 2: Y4	2
40018	Relay set point, VOC	Signed 16	450...2000	450...2000 ppm	1100
40019	Relay set point hysteresis, VOC	Signed 16	0...100	0...100 %	5
40020	Yellow AL3 indicator light illumination limit	Signed 16	450...2000	450...2000 ppm	750
40021	Red AL3 indicator light illumination limit	Signed 16	450...2000	450...2000 ppm	1250
40022	Value shown on the display	Signed 16	0 - 1 - 2 - 3	0: VOC 1: temperature 2: humidity 3: scrolling	3
40023	Not in use	Signed 16	-	-	1
40024	Not in use	Signed 16	-	-	0
40025	Relay set point, temperature	Signed 16	0...500	0.0...50.0 °C	230
40026	Relay set point hysteresis, temperature	Signed 16	0...200	0.0...20.0 °C	20
40027	Relay set point, humidity	Signed 16	0...100	0...100 %	50
40028	Relay set point hysteresis, humidity	Signed 16	0...50	0...50 %	5
40029	Relay function	Signed 16	0 - 1 - 2 - 3 - 4	0: not in use 1: VOC 2: temperature 3: humidity 4: all	1