

Data Sheet

TWA Thermal Wax Actuator

Application



The TWA is a small actuator for electrical on/off controls to activate several types of valves and floor heating manifolds.

The TWA range covers actuators for 24 V (SELV) or 230 V supply in both normally closed (NC) or normally open (NO) versions (valve positions with no supply voltage to the actuator).

NC/S versions with end switch are also available for some actuator types.

The actuator is equipped with a visual position indicator to show the open or closed position of the valve.

The TWA can be connected to the RA, RTD, RAVL and RAV-valves from Danfoss. Furthermore versions for valves with Heimeier/MNG/Oventrop M30x1,5 connection are available.

Other valves must be verified individually to ensure correct valve closing measurement and valve top geometry.

Ordering

Actuator	Connection type	Supply Voltage	Function	Code no.
TWA-A	RA	230 V AC	NC/S*	088H3106
TWA-A	RA	24 V AC/DC	NC	088H3110
TWA-A	RA	24 V AC/DC	NO	088H3111
TWA-A	RA	230 V AC	NC	088H3112
TWA-A	RA	230 V AC	NO	088H3113
TWA-A	RA	24 V AC/DC	NC/S*	088H3114
TWA-V	RAV/VMT	24 V AC/DC	NC	088H3120
TWA-V	RAV/VMT	24 V AC/DC	NO	088H3121
TWA-V	RAV/VMT	230 V AC	NC	088H3122
TWA-V	RAV/VMT	230 V AC	NO	088H3123
TWA-L	RAVL	24 V AC/DC	NC	088H3130
TWA-L	RAVL	24 V AC/DC	NO	088H3131
TWA-L	RAVL	230 V AC	NC	088H3132
TWA-L	RAVL	230 V AC	NO	088H3133
TWA-K	M30x1,5**	230 V AC	NC/S*	088H3105
TWA-K	M30x1,5**	24 V AC/DC	NC	088H3140
TWA-K	M30x1,5**	24 V AC/DC	NO	088H3141
TWA-K	M30x1,5**	230 V AC	NC	088H3142
TWA-K	M30x1,5**	230 V AC	NO	088H3143
TWA-D	RTD	24 V AC/DC	NC	088H3150
TWA-D	RTD	24 V AC/DC	NO	088H3151
TWA-D	RTD	230 V AC	NC	088H3152
TWA-D	RTD	230 V AC	NO	088H3153

* With end-switch (end-switch only 24 V~)

** Connection to Heimeier, MNG and Oventrop valves with M30x1,5 connection. Other valves must be verified individually to ensure correct valve closing measurement and valve top geometry (see page 3).

Technical specifications

Supply voltage	24 V (Class II (SELV)) and 230 V (3 A pre-fuse)
Max. inrush current	24 V: 350 mA, 230 V: 250 mA
Frequency	50-60 Hz
Running power consumption	2 W
Spindle travel time	~3 min.
Ambient temperature	0 °C to +60 °C
Enclosure	IP 41
Cable length	950 mm

Combination overview for Danfoss thermal wax actuator and valves (V) or manifolds (M)

Valve/ Manifold	RA-N (V)	RTD-N (V)	RA-C (V)	RA-FN (V)	RA-G (V)	RTD-G (V)	RAV-/8 (V)	VMT-8 (V)	RAVL-6 (V)	FHD (M)
k_{VS} (m ³ /H)	0,65 to 1,40	0,65 to 1,40	1,20 to 3,30	0,65 to 1,40	2,06 to 4,75	2,00 to 4,40	1,20 to 3,10	1,50 to 3,10	0,20 to 1,50	0,10 to 1,10
Max. Δp (Bar)	0,6	0,6	0,6	0,6	0,2*	0,2*	0,8	0,8	0,6	0,6
Actuator**	TWA-A	TWA-D	TWA-A	TWA-A	TWA-A	TWA-D	TWA-V	TWA-V	TWA-L	TWA-A

* The RA-G/ RTD-G 25 valve has a max. $\Delta p = 0,16$ bar. Consult valve/manifold datasheets for further information.

** If the actuator should be an 24 V or 230 V and normally open (NO) or normally closed (NC), depends mainly of the application, control strategy and the controller connected to the actuator.

Electrical connections

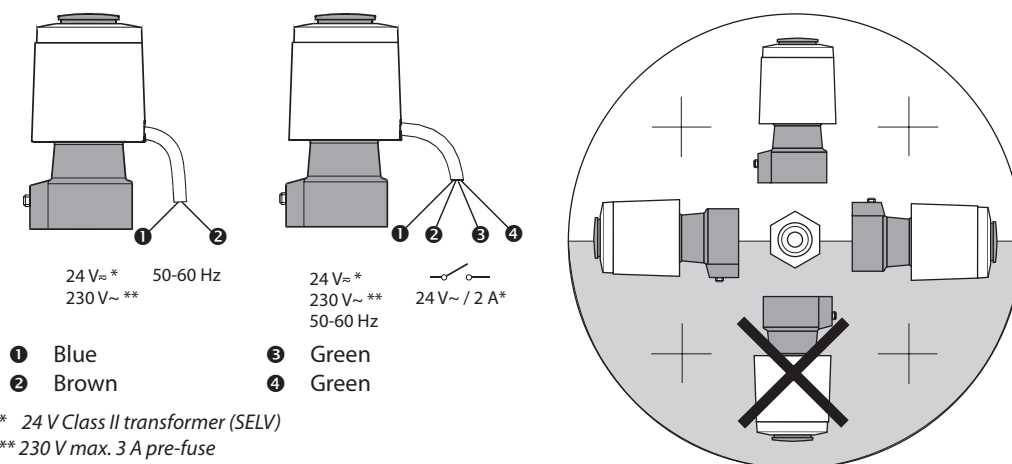

Note! All NC-versions are equipped with a red mounting split on the position indicator to secure easy valve connection. When mounted this split must be removed for correct operation.

Dimensions

TWA-A / RA valves

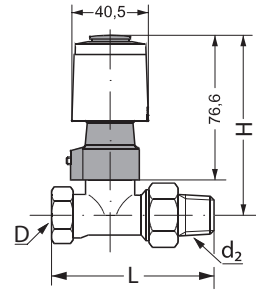

DN	D ISO 7/1	d ₂	Valve type	H [mm]	L [mm]
10	Rp 3/8	R 3/8	RA-N, RA-FN	92	75
15	Rp 1/2	R 1/2	RA-N, RA-FN	92	82
20	Rp 3/4	R 3/4	RA-N, RA-FN	97	98
25	Rp 1	R 1	RA-N, RA-FN	97	125
15	Rp 1/2	R 1/2	RA-G	95	96
20	Rp 3/4	R 3/4	RA-G	95	107
25	Rp 1	R 1	RA-G	99	125

TWA-V / RAV valves

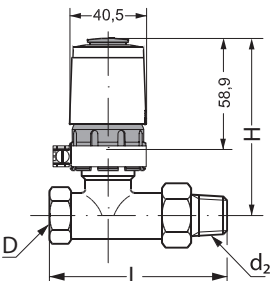

DN	D ISO 7/1	d ₂	RAV	H [mm]	L [mm]
15	Rp 1/2	R 1/2	15/8	74	95
20	Rp 3/4	R 3/4	20/8	74	106
25	Rp 1	R 1	25/8	87	125

TWA-L / RAVL valves

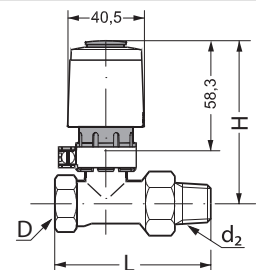

DN	D ISO 7/1	d ₂	RAVL	H [mm]	L [mm]
10	Rp 3/8	R 3/8	10	75	85
15	Rp 1/2	R 1/2	15	75	95
20	Rp 3/4	R 3/4	20	75	106

TWA-V / VMT

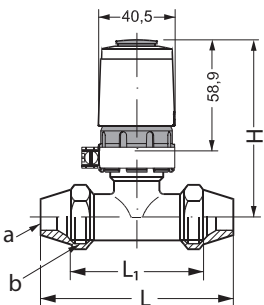

DN	a	b	VMT	H [mm]	L [mm]
15	Ø15, Ø16, Ø18	G 3/4 A	15/8	74	90
20	Ø18, Ø22	G1 A	20/8	74	101
25	Ø28	G1 1/4 A	25/8	87	120

Dimensions

TWA-D / RTD valves

DN	ISO 7/1		Valve type	H [mm]	L [mm]
	D	d ₂			
10	Rp 3/8	R 3/8	RTD-N	83.2	75
15	Rp 1/2	R 1/2	RTD-N	83.2	82
20	Rp 3/4	R 3/4	RTD-N	88.2	98
25	Rp 1	R 1	RTD-N	88.2	125
15	Rp 1/2	R 1/2	RTD-G	86.2	96
20	Rp 3/4	R 3/4	RTD-G	86.2	107
25	Rp 1	R 1	RTD-G	90.2	125

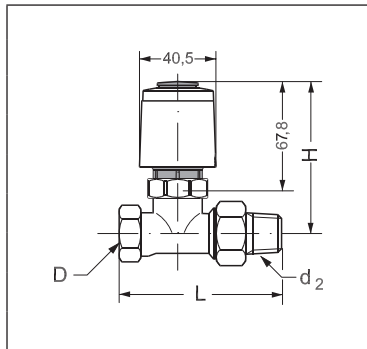

TWA-K



Danfoss A/S

Heating Segment • heating.danfoss.com • +45 7488 2222 • E-Mail: heating@danfoss.com

Danfoss can accept no responsibility for possible errors in catalogues, brochures and other printed material. Danfoss reserves the right to alter its products without notice. This also applies to products already on order provided that such alterations can be made without subsequential changes being necessary in specifications already agreed. All trademarks in this material are property of the respective companies. Danfoss and all Danfoss logotypes are trademarks of Danfoss A/S. All rights reserved.