

User Guide

# ECL Comfort 210 / 296 / 310

English version





**Safety Note**

Necessary assembly, start-up, and maintenance work must be performed by qualified and authorized personnel only.

## Thank you for buying a Danfoss product

### Table of Contents

1.0 Symbols .....	4
2.0 How to navigate.....	5
3.0 Choose your favorite display.....	6
4.0 Setting the temperatures.....	7
5.0 Setting your personal schedule.....	8
6.0 Holiday program.....	9
7.0 Frequently asked questions.....	10



# 1.0 Symbols

## ECL Comfort 210 / 296 / 310

	Outdoor temp.	<b>Temperature</b>
	Relative humidity indoor	
	Room temp.	
	DHW temp.	
	Position indicator	<b>Mode</b>
	Scheduled mode	
	Comfort mode	
	Saving mode	
	Frost protection mode	
	Manual mode	
	Standby	
	Cooling mode	
	Active output override	<b>Circuit</b>
	Optimized start or stop time	
	Heating	
	Cooling	
	DHW (domestic hot water)	<b>Controlled component</b>
	Common controller settings	
	Pump ON	
	Pump OFF	
	Fan ON	
	Fan OFF	
	Actuator opens	
	Actuator closes	
	Actuator, analogue control signal	
	Pump / fan speed	
	Damper ON	
	Damper OFF	

	Alarm
	Letter
	Event
	Monitoring temperature sensor connection
	Display selector
	Max. and min. value
	Trend in outdoor temperature
	Wind speed sensor
	Sensor not connected / not used
	Sensor connection short-circuited
	Fixed comfort day (holiday)
	Active influence
	Heating active (+) Cooling active (-)
	Number of heat exchangers

### Additional symbols, ECA 30 / 31

	ECA Remote Control Unit
	Connection address (master: 15, slaves: 1 - 9)
	Day off
	Holiday
	Relaxing (extended comfort period)
	Going out (extended saving period)



In ECA 30 / 31 only the symbols that are relevant to the application in the controller are displayed.

## 2.0 How to navigate

You navigate in the controller by turning the dial left or right to the desired position (◀▶).

The position indicator in the display (▶) will always show you where you are.

Push the dial to confirm your choices (👉).

The display examples are from a two-circuit application: One heating circuit (⏏) and one domestic hot-water (DHW) circuit (🚿). The examples might differ from your application.

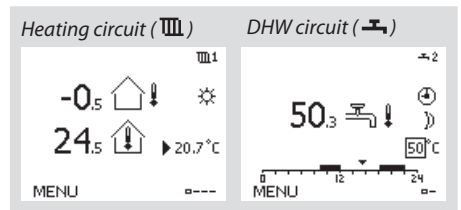
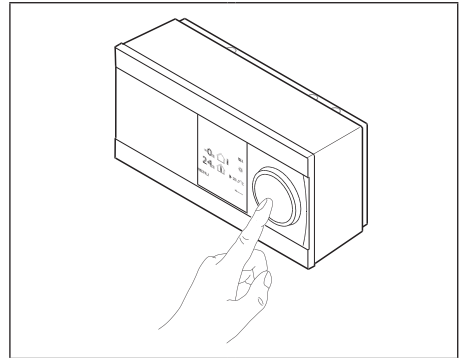

General controller settings such as 'Time and Date', 'Holiday' etc. are placed in 'Common controller settings' (☐☐).

### How to enter common controller settings:

Action:	Purpose:	Examples:
◀▶	Choose 'MENU' in any circuit	MENU
👉	Confirm	
◀▶	Choose the circuit selector at the top right corner in the display	
👉	Confirm	
◀▶	Choose common controller settings	☐☐
👉	Confirm	





### 3.0 Choose your favorite display

Your favorite display is the display you have chosen as the default display. The favorite display will give you a quick overview of the temperatures or units that you want to monitor in general.

If the dial has not been activated for 20 min., the controller will revert to the overview display you have chosen as favorite.

#### Heating circuit

Dependent on the chosen display, the overview displays for the heating circuit inform you about:

- actual outdoor temperature (-0.5)
- controller mode ()
- actual room temperature (24.5)
- desired room temperature (20.7 °C)
- trend in outdoor temperature (→)
- min. and max. outdoor temperatures since midnight ()
- date (23.02.2015)
- time (7:43)
- comfort schedule of the current day (0 - 12 - 24)
- state of the controlled components (M2, P2)
- actual flow temperature (49 °C), (desired flow temperature (31))
- return temperature (24 °C) (limitation temperature (50))

#### DHW circuit

Dependent on chosen display, the overview displays for the DHW circuit inform you about:

- actual DHW temperature (50.3)
- controller mode ()
- desired DHW temperature (50 °C)
- comfort schedule of the current day (0 - 12 - 24)
- state of the controlled components (M1, P1)
- actual DHW temperature (50 °C), (desired DHW temperature (50))
- return temperature (- - °C) (limitation temperature (30))



Change between displays by turning the dial until you reach the display selector () at bottom right side of the display. Turn the dial and push to choose your favorite overview display.

Overview display 1:

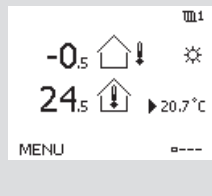

Overview display 2:

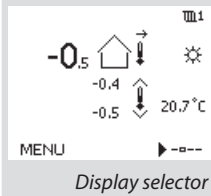

Overview display 3:

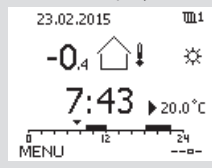

Overview display 4:

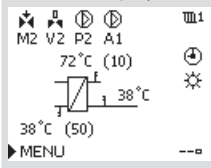

Overview display 1:

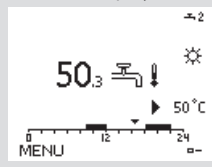

Overview display 2:

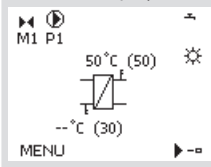

## 4.0 Setting the temperatures

Depending on the chosen circuit and mode, it is possible to enter all daily settings directly in the overview displays.

### Setting the desired room temperature

The desired room temperature can easily be adjusted in the overview displays for the heating circuit.

Action:	Purpose:	Examples:
	Desired room temperature	20.5
	Confirm	
	Adjust the desired room temperature	21.0
	Confirm	

If you want to change the desired room temperature for saving mode, choose the mode selector and select saving mode.

### Setting the desired DHW temperature

The desired DHW temperature can easily be adjusted in the overview display for the DHW circuit.

Action:	Purpose:	Examples:
	Desired DHW temperature	50
	Confirm	
	Adjust the desired DHW temperature	55
	Confirm	

In addition to the information about desired and actual DHW temperature, today's schedule is visible.

### Setting the desired room temperature, ECA 30 / ECA 31

The desired temperature can be set as in the controller. However, other symbols can be present in the display (please see the page about symbols).

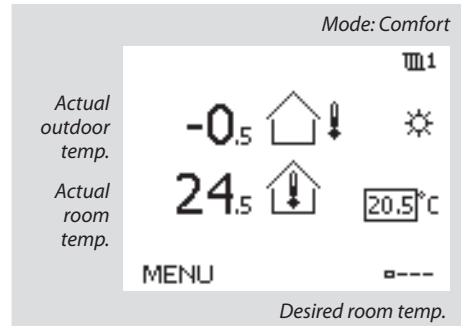

The setting of the desired room temperature is important even if a room temperature sensor / Remote Control Unit is not connected.

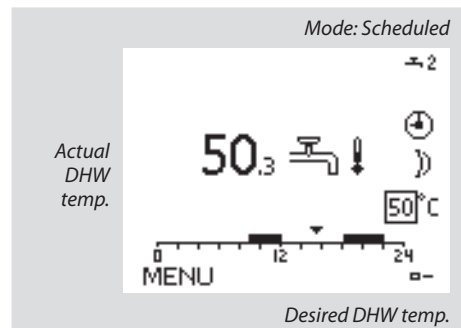

With the ECA 30 / ECA 31 you can override the desired room temperature set in the controller temporarily by means of the override functions:

## 5.0 Setting your personal schedule

The schedule consists of a 7-day week:

M = Monday, T = Tuesday, W = Wednesday,  
 T = Thursday, F = Friday, S = Saturday,  
 S = Sunday.

The schedule will day-by-day show you the start and stop times of your comfort periods (heating / DHW circuits).

### How to change the schedule:

- |         |   |           |
|---------|---|-----------|
| Action: | Purpose:                                      | Examples: |
|         | Choose 'MENU' in any of the overview displays | MENU      |
|         | Confirm                                       |           |
|         | Confirm the choice 'Schedule'                 |           |
|         | Choose the day to change                      | ▶         |
|         | Confirm*                                      | T         |
|         | Go to Start1                                  |           |
|         | Confirm                                       |           |
|         | Adjust the time                               |           |
|         | Confirm                                       |           |
|         | Go to Stop1, Start2 etc. etc.                 |           |
|         | Return to 'MENU'                              | MENU      |
|         | Confirm                                       |           |
|         | Choose 'Yes' or 'No' in 'Save'                |           |
|         | Confirm                                       |           |

\* Several days can be marked.

The chosen start and stop times will be valid for all the chosen days (in this example Thursday and Saturday).

You can set max. 3 comfort periods a day. You can delete a comfort period by setting start and stop times to the same value.

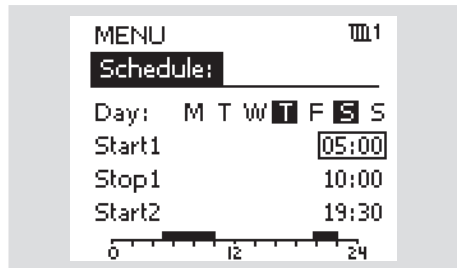
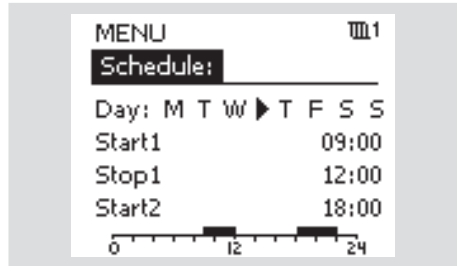

Each circuit has its own schedule. To choose another circuit, go to 'Home', turn the dial and choose the desired circuit.



## 6.0 Holiday program

There is a holiday program for each circuit and a common holiday program for all circuits. Each holiday program contains one or more schedules. It can be set to a start date and an end date. The set period starts on the start date at 00.00 and stops on end date at 24.00. The end date must be at least one day later than the start date.

The holiday program in the 'Common controller settings' is valid for all circuits. The holiday program can also be set individually in the heating or DHW circuits.

### How to set your holiday schedule:

- |         |  |           |
|---------|--|-----------|
| Action: | Purpose:   | Examples: |
|         | Choose 'MENU'  | MENU      |
|         | Confirm  |           |
|         | Choose the circuit selector at the top right corner in the display |           |
|         | Confirm  |           |
|         | Choose a circuit or 'Common controller settings'                   |           |
|         | Confirm  |           |
|         | Go to 'Holiday'  |           |
|         | Confirm  |           |
|         | Choose a schedule  |           |
|         | Confirm  |           |
|         | Confirm choice of mode selector                                    |           |
|         | Choose mode:   |           |
|         | • Comfort  |           |
|         | • Comfort 7-23   |           |
|         | • Saving   |           |
|         | • Frost protection   |           |
|         | Confirm  |           |
|         | Enter start time first and then the end time                       |           |
|         | Confirm  |           |
|         | Go to 'MENU'   |           |
|         | Confirm  |           |
|         | Choose 'Yes' or 'No' in 'Save'.                                    |           |
|         | Choose the next schedule, if required                              |           |

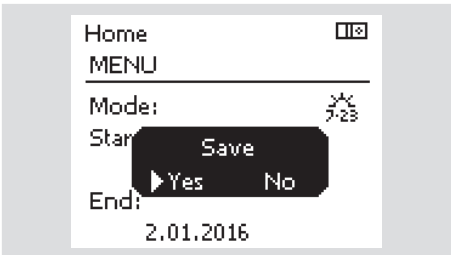
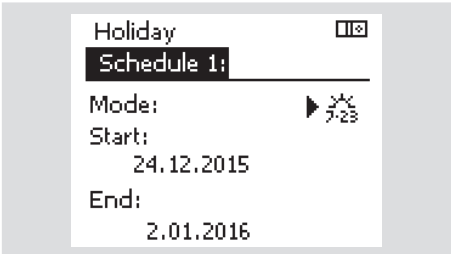
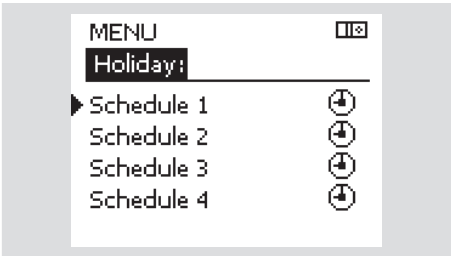

## 7.0 Frequently asked questions

---

### **The time shown in the display is one hour off?**

See 'Time and Date'.

### **The time shown in the display is not correct?**

The internal clock may have been reset, if there has been a power break for more than 72 hours.

Go to the 'Common controller settings' and 'Time & Date' to set the correct time.

### **The ECL Application Key is lost?**

Switch the power off and on again to see the system type and the software generation of the controller or go to 'Common controller settings' > 'Key functions' > 'Application'.

The system type (e.g. TYPE A266.1) and the system diagram is displayed.

Order a replacement from your Danfoss representative (e.g. ECL Application Key A266).

Insert the new ECL Application Key and copy your personal settings from the controller to the new ECL Application Key, if required.

### **The room temperature is too low?**

Make sure that the radiator thermostat does not limit the room temperature.

If you still cannot obtain the desired room temperature by adjusting the radiator thermostats, the flow temperature is too low. Increase the desired room temperature (display with desired room temperature). If this does not help, adjust the 'Heat curve' ('Flow temp.').

### **The room temperature is too high during saving periods?**

Make sure that the min. flow temperature limitation ('Temp. min.') is not too high.

### **How to make an extra comfort period in the schedule?**

You can set an additional comfort period by adding new 'Start' and 'Stop' times in 'Schedule'.

### **How to remove a comfort period in the schedule?**

You can remove a comfort period by setting 'Start' and 'Stop' times to the same value.

### **How to restore your personal or the factory settings?**

See the Operating Guide. Additional documentation for ECL Comfort 210, 296 and 310, modules and accessories is available on [www.heating.danfoss.com](http://www.heating.danfoss.com).

### **Why can't the settings be changed?**

The ECL Application Key has been removed.

### **How to react on alarms (🔔)?**

An alarm indicates that the system is not operating satisfactorily. See the Operating Guide. Additional documentation for ECL Comfort 210, 296 and 310, modules and accessories is available on [www.heating.danfoss.com](http://www.heating.danfoss.com).



**Disposal note**

This symbol on the product indicates that it may not be disposed of as household waste.

It must be handed over to the applicable take-back scheme for the recycling of electrical and electronic equipment.

- Dispose of the product through channels provided for this purpose.
- Comply with all local and currently applicable laws and regulations.

Additional documentation for ECL Comfort  
210, 296 and 310, modules and accessories is  
available on [www.heating.danfoss.com](http://www.heating.danfoss.com)



**Danfoss A/S**

Heating Segment • danfoss.com • +45 7488 2222 • E-Mail: [heating@danfoss.com](mailto:heating@danfoss.com)

Danfoss can accept no responsibility for possible errors in catalogues, brochures and other printed material. Danfoss reserves the right to alter its products without notice. This also applies to products already on order provided that such alterations can be made without consequential changes being necessary in specifications already agreed.  
All trademarks in this material are property of the respective companies. Danfoss and all Danfoss logotypes are trademarks of Danfoss A/S. All rights reserved.