

Beck.

The differential pressure transmitter for air



Differential pressure transmitter 984



General description

The differential pressure transmitters of the 984 series are used to measure differential pressure, overpressure and vacuum. They provide up to 8 pressure ranges and 2 output signals, which are easily selectable by jumper or rotary selector switch.

Applications

Monitoring of gaseous, non-combustible and non-aggressive media.

Possible usage areas are:

- Building automation and air conditioning systems
- Overpressure measurement in clean rooms and laboratories
- Measurement of constant pressure in VAV applications
- Dynamic filter and ventilator monitoring

Configurable pressure range

For an optimum adaptation to the application, the transmitter can be switched between various pressure ranges. The factory setting is the most sensitive range. For the series 984M and 984A the less sensitive second range will be selected by simply removing a jumper. For the series 984Q the available eight ranges can be selected by a rotary selector switch.

Output signal selection

The output signal of the 3-wire version can be changed between 0 ...10 Volt and 4 ... 20 mA by removing a jumper. The series 984M is also available in a 2-wire version with 4 ... 20 mA output signal.

Configurable response time

The response time of the output signal can be configured using a jumper. If the jumper is in place the response time is slow (factory setting), which is useful for suppressing brief pressure peaks. If the application requires a fast response time the jumper must be removed.

Easy offset calibration

The output signal of the 984M series can be calibrated to zero by pressing the M push-button in a pressureless state of the transmitter. The series 984A and 984Q perform an automated zero offset compensation.

Volume flow measurement (optional)

The shape of the output signal can be switched from linear to square root using a jumper in order to measure the volume flow via a differential pressure.

Switching output (optional, not available with 2-wire version)

To give a switch signal at an user defined pressure level the transmitter has an adjustable transistor switching output (npn NO) with a maximum switching capacity of 30 VDC/100 mA.

Display (optional, not available with 2-wire version)

In addition to the analogue output signal the pressure value can be read out on a red LED-display in Pascal or other pressure units.

Measuring method

Piezoresistive pressure transducer

Mounting position

Can be mounted in any position. The zero offset calibration eliminates any possible position error.

Overview on technical data

Series	984M	984M	984A	984Q
Electrical connection	2-wire	3-wire	3-wire	3-wire
Measuring method	Piezoresistive pressure transducer			
Supply voltage	18...30 VDC	18...30 VAC / VDC	18 ÷ 30 VAC / VDC	18 ÷ 30 VAC / VDC
Output signal selectable	.	with jumper	with jumper	with jumper
Output signal 0 ... 10 V	.			
Output signal 4 ... 20 mA				
Output signal 0 ... 5 V	.			
Output signal 0 ... 20 mA	.			
LED display, red, 4 digits	.			
Switching output for max 30 VDC / 100 mA	.			
Output signal selection from linear to square root				
Max. current draw without display VDC / VAC	21 / . mA	50 / 140 mA	60 / 150 mA	60 / 150 mA
Max. current draw with display VDC / VAC	. / .	70 / 180 mA	80 / 190 mA	80 / 190 mA
Load for 4 ... 20 mA output		20 ... 500		
Load for 0 ... 10 V output	.	~ 1k (m10 mA)	~ 1k (m10 mA)	~ 1k (m10 mA)
Pressure medium	Air, non-combustible and non-aggressive gases			
Configuration of pressure range	with jumper	with jumper	with jumper	with rotary switch
Max. number of pressure range	2	2	2	8
Only one customized pressure range				
Manuel offset compensation			.	.
Automated offset compensation	.	.		
Working and storage temperature	-20 ÷ +70°C	-20 ÷ +70°C	-10 ÷ +50°C	-10 ÷ +50°C
Linearity (incl. hysteresis and repeatability)		m±0.5% FS, min. ±1 Pa		
Uncertainty (Total Error Band w/o long-term and temperature effects)		±1% FS, min. ±1 Pa		
Long-term stability	m±1% FS	m±1% FS	n.r.	n.r.
Humidity		0 ... 95% rel., non-condensing		
Response time 0.2 s and 1 s (standard)				
Response time free selectable between 0.2 s and 20 s				
Process connection P1 and P2		Hose connection with 6 mm outer diameter		
Electrical connection		Screw terminal block for wires and strands up to 1.5 mm ²		
Mounting		Screw mounting with serrated screws		
Housing material		Housing with process connection P2 (.) made from ABS Base part with process connection P1 (+) made from POM		
Housing dimensions		approx. Ø 85 x 58 mm		
Weight	approx. 120 gr	approx. 135 gr	approx. 150 gr	approx. 150 gr
Protection class acc. to EN 60529		IP54 with protection cap or IP00 without protection cap		
CE Conformance acc. to EN 61326				
RoHS Conformance acc. to 2011/65/EU				

Accuracy specifications according to EN 60770 based on the pressure measurement at 23 °C

standard equipment

optional equipment

Differential pressure transmitter 984M

with manual offset compensation and 2 pressure ranges

Pressure ranges

Model	Range 1	Range 2	Overload capacity	Bursting pressure	Additional uncertainty with temperature [% FS/10K]
984M.3X3	-50 \bar{o} 0 \bar{o} +50 Pa	-	60 kPa	100 kPa	± 1.0
984M.3W3	-100 \bar{o} 0 \bar{o} +100 Pa	-	60 kPa	100 kPa	± 0.7
984M.323	0 \bar{o} 100 Pa	0 \bar{o} 250 Pa	60 kPa	100 kPa	± 0.7
984M.333	0 \bar{o} 250 Pa	0 \bar{o} 500 Pa	60 kPa	100 kPa	± 0.5
984M.343	0 \bar{o} 500 Pa	0 \bar{o} 1000 Pa	75 kPa	125 kPa	± 0.3
984M.353	0 \bar{o} 1 kPa	0 \bar{o} 2.5 kPa	85 kPa	135 kPa	± 0.3
984M.373	0 \bar{o} 5 kPa	0 \bar{o} 10 kPa	85 kPa	135 kPa	± 0.3
984M.393	0 \bar{o} 25 kPa	0 \bar{o} 50 kPa	200 kPa	400 kPa	± 0.3
984M.3A3	0 \bar{o} 50 kPa	0 \bar{o} 100 kPa	200 kPa	400 kPa	± 0.3

Further pressure ranges on request.

Order matrix

IP protection class	IP 54 with cable conduit M20x1.5 IP 54 with cap nut conduit AF20	984M.3						
Configurable pressure range	- 50 ... 0 ... +50 Pa (-0.5 ... 0 ... +0.5 mbar) - 100 ... 0 ... +100 Pa (-1.0 ... 0 ... +1.0 mbar) 0 ... 100 Pa (1.0 mbar) 0 ... 250 Pa (2.5 mbar) 0 ... 250 Pa (2.5 mbar) 0 ... 500 Pa (5.0 mbar) 0 ... 500 Pa (5.0 mbar) 0 ... 1000 Pa (10 mbar) 0 ... 1 kPa (10 mbar) 0 ... 2.5 kPa (25 mbar) 0 ... 5 kPa (50 mbar) 0 ... 10 kPa (100 mbar) 0 ... 25 kPa (250 mbar) 0 ... 50 kPa (500 mbar) 0 ... 50 kPa (500 mbar) 0 ... 100 kPa (1.0 bar)	5	X					
Pressure unit	mbar Pa			1				
Output signal and supply voltage	0 ... 10 V or 4 ... 20 mA, 3-wire, with switching output 0 ... 10 V or 4 ... 20 mA, 3-wire, without switching output 4 ... 20 mA or 0 \bar{o} 10 V, 3-wire, with switching output 4 ... 20 mA or 0 \bar{o} 10 V, 3-wire, without switching output 4 ... 20 mA , 2-wire				1			
Display	no display with LED-display (only for 3-wire)						0	
Electrical connection	via screw terminal block						1	4b

Factory settings printed in bold type.

Terminal assignments

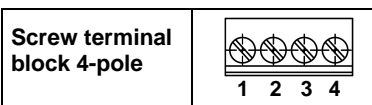

3-wire with switching output

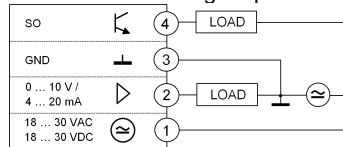

4	Switching output (SO)
3	Ground (GND)
2	Output signal (0 \bar{o} 10 V / 4 \bar{o} 20 mA)
1	Supply voltage (18...30 VAC / VDC)

3-wire without switching output

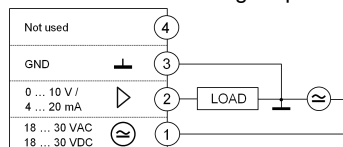

4	Not used
3	Ground (GND)
2	Output signal (0 \bar{o} 10 V / 4 \bar{o} 20 mA)
1	Supply voltage (18...30 VAC / VDC)

2-wire

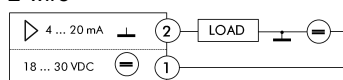

2	Output signal (4 \bar{o} 20 mA)
1	Supply voltage (18...30 VDC)

Differential pressure transmitter 984A

with automated offset compensation and 2 pressure ranges

Pressure ranges

Model	Range 1	Range 2	Overload capacity	Bursting pressure	Additional uncertainty with temperature [% FS/10K]
984A.3E3	-25 $\bar{0}$ 0 $\bar{0}$ +25 Pa	-	60 kPa	100 kPa	± 0.7
984A.3X3	-50 $\bar{0}$ 0 $\bar{0}$ +50 Pa	-	60 kPa	100 kPa	± 0.5
984A.3W3	-100 $\bar{0}$ 0 $\bar{0}$ +100 Pa	-	60 kPa	100 kPa	± 0.3
984A.303	0 $\bar{0}$ 25 Pa	0 $\bar{0}$ 50 Pa	60 kPa	100 kPa	± 0.7
984A.313	0 $\bar{0}$ 50 Pa	0 $\bar{0}$ 100 Pa	60 kPa	100 kPa	± 0.5
984A.323	0 $\bar{0}$ 100 Pa	0 $\bar{0}$ 250 Pa	60 kPa	100 kPa	± 0.3
984A.333	0 $\bar{0}$ 250 Pa	0 $\bar{0}$ 500 Pa	60 kPa	100 kPa	n.r.
984A.343	0 $\bar{0}$ 500 Pa	0 $\bar{0}$ 1000 Pa	75 kPa	125 kPa	n.r.
984A.353	0 $\bar{0}$ 1 kPa	0 $\bar{0}$ 2.5 kPa	85 kPa	135 kPa	n.r.
984A.373	0 $\bar{0}$ 5 kPa	0 $\bar{0}$ 10 kPa	85 kPa	135 kPa	n.r.
984A.393	0 $\bar{0}$ 25 kPa	0 $\bar{0}$ 50 kPa	200 kPa	400 kPa	n.r.

Weitere Druckmessbereiche auf Anfrage.

Order matrix

		984A.3				
IP protection class	IP 54 with cable conduit M20x1.5 IP 54 with cap nut conduit AF20	5				
Configurable pressure range	- 25 ... 0 ... +25 Pa (-0.25 ... 0 ... +0.25 mbar) - 50 ... 0 ... +50 Pa (-0.5 ... 0 ... +0.5 mbar) - 100 ... 0 ... +100 Pa (-1.0 ... 0 ... +1.0 mbar) 0 ... 25 Pa (0.25 mbar) 0 ... 50 Pa (0.5 mbar) 0 ... 50 Pa (0.5 mbar) 0 ... 100 Pa (1.0 mbar) 0 ... 100 Pa (1.0 mbar) 0 ... 250 Pa (2.5 mbar) 0 ... 250 Pa (2.5 mbar) 0 ... 500 Pa (5.0 mbar) 0 ... 500 Pa (5.0 mbar) 0 ... 1000 Pa (10 mbar) 0 ... 1 kPa (10 mbar) 0 ... 2.5 kPa (25 mbar) 0 ... 5 kPa (50 mbar) 0 ... 10 kPa (100 mbar) 0 ... 25 kPa (250 mbar) 0 ... 50 kPa (500 mbar)	5	E			
Pressure unit	mbar Pa			1		
Output signal and supply voltage	0 ... 10 V or 4 ... 20 mA, 3-wire, with switching output 0 ... 10 V or 4 ... 20 mA, 3-wire, without switching output 4 ... 20 mA or 0 $\bar{0}$ 10 V, 3-wire, with switching output 4 ... 20 mA or 0 $\bar{0}$ 10 V, 3-wire, without switching output				1	
Display	no display with LED-display					0
Electrical connection	via screw terminal block					1
Factory settings printed in bold type.						

Terminal assignments

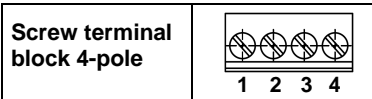

3-wire with switching output

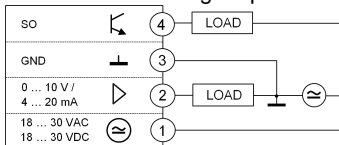

4	Switching output (SO)
3	Ground (GND)
2	Output signal (0 $\bar{0}$ 10 V / 4 $\bar{0}$ 20 mA)
1	Supply voltage (18...30 VAC / VDC)

3-wire without switching output

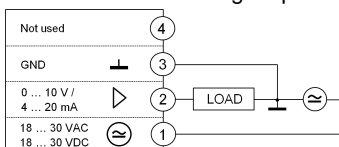

4	Not used
3	Ground (GND)
2	Output signal (0 $\bar{0}$ 10 V / 4 $\bar{0}$ 20 mA)
1	Supply voltage (18...30 VAC / VDC)

Differential pressure transmitter 984Q

with automated offset compensation and 8 pressure ranges

Pressure ranges

Model	Position rotary switch	Pressure range	Overload capacity	Bursting pressure	Additional uncertainty with temperature [% FS/10K]
984Q.343	1	0 ÷ 100 Pa	75 kPa	125 kPa	± 0.7
	2	0 ÷ 250 Pa	75 kPa	125 kPa	± 0.3
	3	0 ÷ 500 Pa	75 kPa	125 kPa	n.r.
	4	0 ÷ 1000 Pa	75 kPa	125 kPa	n.r.
	5	-50 ÷ 0 ÷ +50 Pa	75 kPa	125 kPa	± 0.7
	6	-100 ÷ 0 ÷ +100 Pa	75 kPa	125 kPa	± 0.5
	7	-250 ÷ 0 ÷ +250 Pa	75 kPa	125 kPa	n.r.
	8	-500 ÷ 0 ÷ +500 Pa	75 kPa	125 kPa	n.r.
	9	fixed output signal 0 V / 4 mA	-	-	-
984Q.353	1	-100 ÷ 0 ÷ +100 Pa	85 kPa	125 kPa	± 1.0
	2	0 ÷ 100 Pa	85 kPa	125 kPa	± 1.5
	3	0 ... 200 Pa	85 kPa	125 kPa	± 1.0
	4	0 ... 500 Pa	85 kPa	125 kPa	± 0.5
	5	0 ... 1000 Pa	85 kPa	125 kPa	± 0.3
	6	0 ... 1500 Pa	85 kPa	125 kPa	n.r.
	7	0 ... 2000 Pa	85 kPa	125 kPa	n.r.
	8	0 ... 2500 Pa	85 kPa	125 kPa	n.r.
	9	fixed output signal 10 V / 20 mA	-	-	-

Further pressure ranges on request.

Bestellmatrix

IP protection class	IP 54 with cable conduit M20x1.5 IP 54 with cap nut conduit AF20	984Q.3						
Configurable pressure range	see pressure ranges max. 1000 Pa (10 mbar) max. 2500 Pa (25 mbar)	5	4					
Pressure unit	mbar Pa		5					
Output signal and supply voltage	0 ... 10 V or 4 ... 20 mA, 3-wire, with switching output 0 ... 10 V or 4 ... 20 mA, 3-wire, without switching output 4 ... 20 mA or 0 ÷ 10 V, 3-wire, with switching output 4 ... 20 mA or 0 ÷ 10 V, 3-wire, without switching output			1				
Display	no display with LED-display			3				
Electrical connection	via screw terminal block						0	
							1	4b

Factory settings printed in bold type.

Terminal assignments

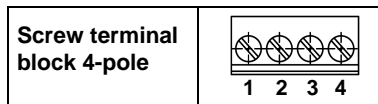

3-wire with switching output

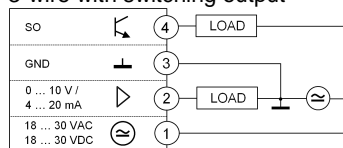

4	Switching output (SO)
3	Ground (GND)
2	Output signal (0 ÷ 10 V / 4 ÷ 20 mA)
1	Supply voltage (18...30 VAC / VDC)

3-wire without switching output

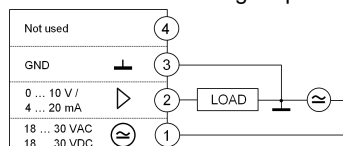

4	Not used
3	Ground (GND)
2	Output signal (0 ÷ 10 V / 4 ÷ 20 mA)
1	Supply voltage (18...30 VAC / VDC)

Dimensional Drawings

984 with cap nut conduit AF20

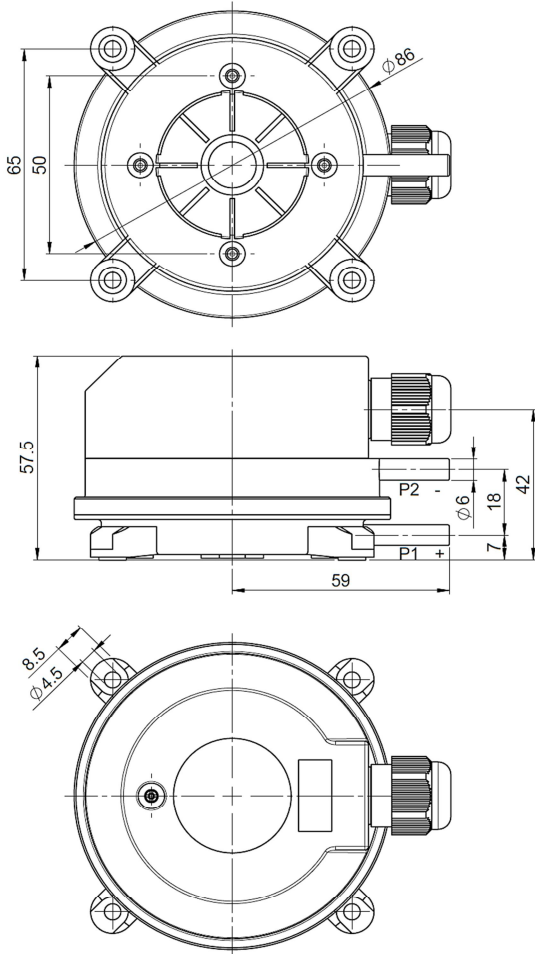

Mounting bracket 6481

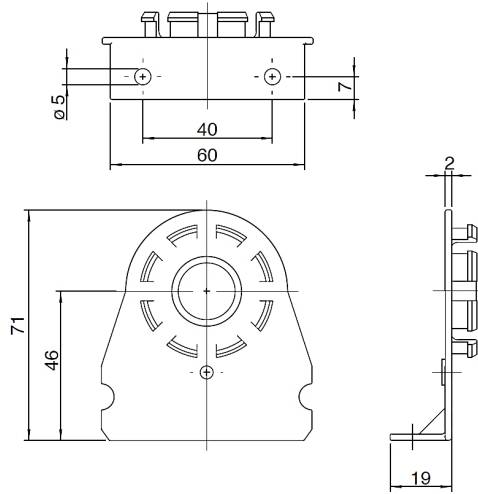

Mounting bracket 6482

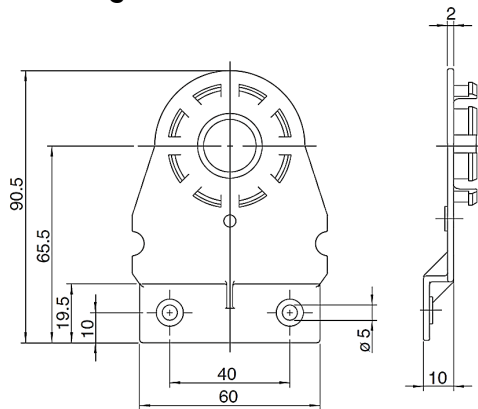

Duct connection for Climaset® 6550/6556

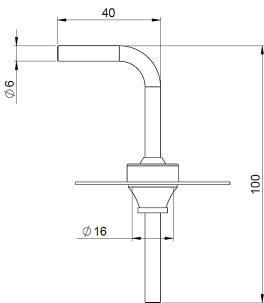

Duct connection for Climaset® 6555/6557

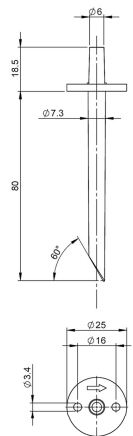

Mounting bracket 6401

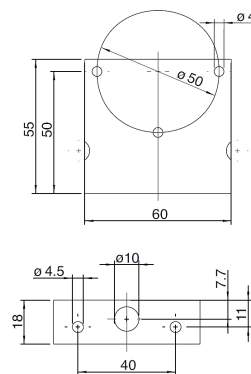

Mounting bracket 6402

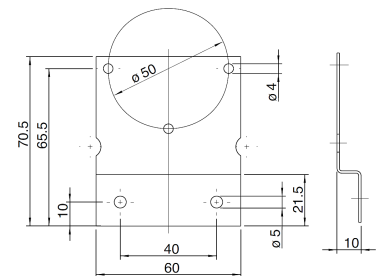

Analog output signal

Linear (Jumper 3 plugged in)

0 . 10 V

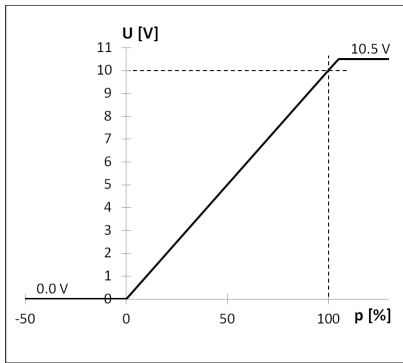

4 . 20 mA

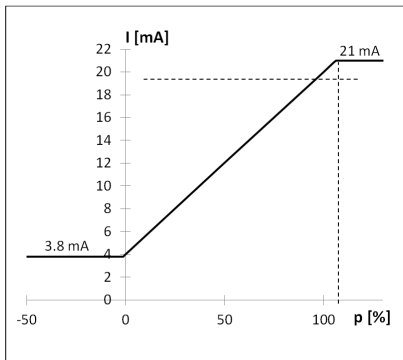

Square root (Jumper 3 open)

0 . 10 V

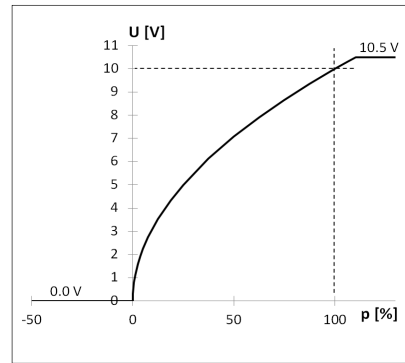

4 . 20 mA

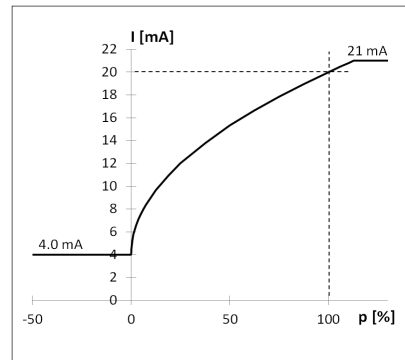

Accessories

Metal mounting bracket S-shaped	Article No. 6402
Metal mounting bracket L-shaped	Article No. 6401
Snap-on plastic bracket S-shaped	Article No. 6482
Snap-on plastic bracket L-shaped	Article No. 6481
Climaset® consisting of 2m PVC hose and 2 plastic pipes	Article No. 6555
Climaset® consisting of 2m Silicone hose and 2 plastic pipes	Article No. 6557
Climaset® consisting of 2m PVC hose and 2 angled metal pipes	Article No. 6550
Climaset® consisting of 2m Silicone hose and 2 angled metal pipes	Article No. 6556
Duct connecting pipe for Climaset® 6555	Article No. 6551
Angled metal pipe for Climaset® 6550	Article No. 6552
Rubber grommet for Climaset® 6550	Article No. 6553
Roll with 100 m PVC hose	Article No. 6424
Roll with 100 m Silicone hose	Article No. 6425
Cap nut conduit AF20 with integrated cable strain relief	Article No. 6562
M20x1.5 cable conduit including sealing and counter screw	Article No. 6568
Folding box for individual packing (with accessories)	Article No. 6428
Folding box for individual packing (with accessories)	Article No. 6429



Beck GmbH
 Druckkontrolltechnik
 P.O. Box 11 31
 D-71140 Steinenbronn
 Telephone +49 (71 57) 52 87-0
 Telefax +49 (71 57) 52 87-83
 e-mail sales@beck-sensors.com
<http://www.beck-sensors.com>